

MM-Info „Standard“

Info folder with general information
about PolymerMetals for clients



MultiMetall
the MetalExistenceCompany®

PolymerMetall® • MultiMetall® • Ceramium® • Molymetall® • Sealium® • XETEX®

MultiMetall • P.O. Box 12 02 64 • 41720 Viersen • Germany
Tel: +49 (0) 21 62-97 00 9-0 • Fax: +49 (0) 21 62-97 00 9-11
Email: info@polymermetal.com • Web: www.polymermetal.com

MultiMetall is the manufacturer of PolymerMetall®.

For more than 40 years MultiMetall invests in polymer-metallic material technologies for the maintenance of metals and alloys.

In the fight with these special tasks our polymer-metallic materials are professionally equipped.

Tough hard, wear resistant and long-lived – even under more difficult conditions.

Successful on oily or under water lying repair areas.

Good to exceptionally good is the assessment as per certificate 301954. (Lloyds Register of Shipping)

Superiority due to mechanical physical data, which counteracts the constant load.

The continuous compressive strength under load can be more than 160 MPa.

A force of 245 MPa is necessary to reach the upper limit. (test report Fraunhofer Institut Germany)

Difficult to damage when attacked by chemicals e.g. acids, alkaline solutions, solvents, salts, gases etc.

PolymerMetall® has a high potential of research and development.

The equipment that lets metals live longer.

MultiMetall

the MetalExistenceCompany®



PolymerMetall® for the repair of metallic devices

www.polymermetal.com

MultiMetall

P.O. Box 12 02 64 / 41720 Viersen / Germany

Tel: +49-2162-97009-0 / Fax: +49-2162-97009-11

info@polymermetal.com / www.polymermetal.com



PolymerMetall®

Introduction

MultiMetall Germany invests for more than 40 years in polymer-metallic material technologies for the maintenance of metals and alloys. In plants and constructions often functional particularly important components are exposed to stresses like break, tear, corrosion, cavitation, chemical or thermal demands. Components treated with PolymerMetals can be preventatively protected against above mentioned stresses. Furthermore MultiMetall's cold repair technology facilitates a gentle material treatment and a durable repair of damaged parts.

Wherever technical security is concerned, PolymerMetals offer the required quality. Certificates from classification societies, test results from research laboratories as well as positive evaluations from customers worldwide verify that fact. Even at problematic surfaces, on oil, grease, fuel or under water, PolymerMetals are used. This technology is called „direct-MM-bonding“.

PolymerMetals - Excellent properties

Engineers and technicians need to have a clear picture of the quality of the products available on the market to be able to choose the best product. Therefore we decided to list excellent properties of different MultiMetall-products in the following overview. Please make your own comparison and let the figures speak for themselves.

Compressive strength (DIN ISO 604):	211 MPa
Compressive strength after post-curing (DIN ISO 604):	245 MPa
Flexural strength (DIN 53452):	110 MPa
Hardness (DIN 50351):	55 Brinell
Modulus of elasticity at 20 °C (DIN EN ISO 6721-5):	15.600 MPa (2.262.000 psi)
Modulus of torsion at 20 °C (DIN EN ISO 6721-2):	5.900 MPa (855.500 psi)
Corrosion:	none
Electrochemical corrosion (DIN 50900):	none
Resist against internal pressure:	300 bar
Totally cured at temperatures up to:	minus 30 °C
Total curing time:	3 min
Repairs in high temperature range at metal temperatures up to:	300 °C
at water cooled metal surfaces up to:	550 °C
Repairs of all metals and alloys	
Application of oily, greasy or fuel contaminated metal surfaces	
Application under water or on wet metal surfaces	
Surface protection against erosion, abrasion, cavitation & corrosion	
Chemical resistance very high against acids, lyes & solvents	
Storage over 5 years without any loss of quality possible	

Acceptance by classification societies

American Bureau of Shipping • China Classification Society • Det Norske Veritas • Germanischer Lloyd • Lloyd's Register of Shipping • Nippon Kaiji Kyokai • Russian Type Approval

Availability

Technical data sheets are generally available in German or English language. PolymerMetals are only produced in Germany and delivered worldwide within short time by MultiMetall. In addition to that our products are internationally available from many MultiMetall-partners. Ask for further products from MultiMetall.

Repair of components with PolymerMetals

air sleeves • axles • bearing housings • bearing seating • boiler • bridge bearings • compensators • compressors • condensers / capacitors • conveyor belts • cooling tubes • cyclone • cylinder barrels • cylinder sleeves • engine blocks • engines • exhaust pipelines • exhaust pipes • exhaust turbines • gaskets • gearbox housings • guide rails • heat exchangers • housings for gas inlet and outlet • hulls • hydraulic cylinders • hydraulic oil pipes • hydraulic pistons • impellers • kort nozzles • oil coolers • oil pipelines / oil feed pipes • oil tanks • petrol pipelines / petrol feed pipes • petrol tanks • plain bearings • plungers • propellers • pumps • rudder bearings • seals • shaft plates • shafts • slab frames • spline shafts • steam pipelines / steam feed pipes • tappet guides • transformers • turbine housings • turbochargers • V-grooves / keyways • valve housings • valves • vibration dampers • water coolers • water pipes • water tanks

Trademarks

MultiMetall®
 PolymerMetal® • Ceramium®
 Molymetall® • Sealium® • XETEX®

Reference list (Extract of German customers)

ABB AG • AG der Dillinger Hüttenwerke • AIDA Cruises • Alstom Power Service GmbH • Atlas Copco Energas GmbH • Blohm + Voss Industrietechnik GmbH • Bombardier Transportation GmbH • BVG Berliner Verkehrsbetriebe • Carl Büttner Ship Management • Continental AG Automotive Systems • Daimler AG • DB AG • Deutsche BP AG • Deutz AG • E.ON AG • ENSO Energie Sachsen Ost AG • Erdgas Südsachsen GmbH • Europipe GmbH • Evonik Power Saar GmbH • German Tanker Shipping GmbH & Co. Ship Owners & Tanker Operators • HeidelbergCement AG • Henschel Industrietechnik GmbH • HKM Hüttenwerke Krupp Mannesmann GmbH • Holborn Europa Raffinerie GmbH • IVECO Motors FPT Deutschland • K + S KALI GmbH • KKW Krümmel • KKW Brokdorf • KS Aluminium-Technologie GmbH • KSB AG • LEW Lechwerke AG • LH Luitpoldhütte AG • MAN Diesel SE • Metalock Industrie Service GmbH • MTU Friedrichshafen GmbH • N-ERGIE AG • Norddeutsche Reedereien H. Schuldt GmbH & Co KG • PCK Raffinerie GmbH • Peiner Umformtechnik GmbH • Pirelli Kabel & Systeme GmbH & Co.KG • Porsche AG • Ruhrpumpen GmbH • RWE AG • Saarstahl AG • Salzgitter AG • Shell Deutschland Oil GmbH • Siemens AG Power Generation • Stadtwerke München • Stadtwerke Trier • ThyssenKrupp Industrieservice GmbH • ThyssenKrupp Marine Systems Blohm & Voss Repair GmbH • ThyssenKrupp Steel Europe AG • Vattenfall Europe AG • ZF Friedrichshafen AG

MultiMetall

the MetalExistenceCompany®



Overview product range

MM-metal SS-steelceramic

MM-metal SS-steelceramic is the PolymerMetal with the widest range of application for repairs and maintenance of all metals and alloys. MM-metal SS-steelceramic offers a very high quality at mechanical repairs of damaged components (e.g. caused by crack, corrosion, abrasion, impact or chemical stress).

Machinability: SiC-grinding plates, Diamond tools

MM-metal SQ

Characteristic for this PolymerMetal are the easy processing and extreme short curing time. The variable mixing ratio offers application consistencies from pasty to liquid. MM-metal SQ can be used at ambient temperatures up to minus 30 °C.

Machinability: standard tools

MM-metal SS-steel 382

MM-metal SS-steel 382 is a PolymerMetal and construction material. The high performance material MM-metal SS-steel 382 delivers the best technical data under mechanical and physical stress.

Machinability: standard tools

MM-metal SS

PolymerMetals of the SS-basis possess very high quality standards for the reconstitution of metallic components. These PolymerMetals are available with the alloy materials steel, aluminium, copper and bronze.

Machinability: standard tools

MM-metal oL-steelceramic

MM-metal oL-steelceramic is a PolymerMetal tested and certified for the repair of oily, greasy or fuel contaminated metals and alloys in case of stress due to cracks, corrosion, abrasion, impact or chemicals. MM-metal oL-steelceramic can also be used to seal oil, grease or fuel pouring from leaks at systems under pressure.

Machinability: SiC-grinding plates, Diamond tools

MM-metal UW

MM-metal UW is a PolymerMetal with extreme short curing time. It is certified for repairs under water or on wet metal surfaces. Possible application areas of MM-metal UW are the repair of under water components or the sealing of leaks. MM-metal UW can also be used to seal water pouring from leaks at systems under pressure.

Machinability: SiC-grinding plates, Diamond tools

Ceramium®

Ceramium offers maximum wear resistance against continuous material loss on metallic surfaces. With tough hard layers, Ceramium protects against erosion, abrasion, cavitation or corrosion in case of dry or wet or chemical stress.

Machinability: SiC-grinding plates, Diamond tools

Ceramium® CH

Ceramium CH is a wear resistant Polymer-Ceramic with excellent resistance against chemicals. These include inorganic (mineral) and organic (carboxylic) acids - also in concentrated form – as well as halogenated and aromatic hydrocarbons, ester, ketone, alcohols, bases and oxidising salt solutions.

Machinability: SiC-grinding plates, Diamond tools

XETEX® BD

XETEX BD is a cold-setting two-component construction adhesive on basis of epoxy resin / ceramic, which has been developed for high-strength bonding. The application is the joining of materials (e.g. metals, ceramics and plastics) with very high strength at high mechanical, static and dynamic loads.

VP 10-017

VP 10-017 is a tough elastic PolymerCeramic with high impact and cavitation resistance. This extremely smooth surface protection provides a good resistance against chemicals and has a high mechanical-physical load capacity.

VP 10-500

VP 10-500 is a PolymerMetal for repair and maintenance of metals in the high temperature range. It is a hot-hardening material which does have a clearly higher temperature resistance than cold-hardening polymer materials. A high chemical resistance especially against sulphuric acid is given.

Machinability: SiC-grinding plates, Diamond tools

Molymetall®

Molymetall is a PolymerMetal with a very low coefficient of friction and self-lubricating properties. The emergency running properties against solid dry friction such as sliding wear and stick-slip are excellent. After curing, Molymetall can be processed to a finished measure up to the μ -area.

Machinability: standard tools

Sealium®

Mostly Sealium is used as sealant and sealing of metallic casting materials. Furthermore alloys and thermal coated components can be treated with Sealium. As a one-component material with extremely high capillary activity, Sealium penetrates micro-porosities or hairline cracks and reacts in the structure of the metallic material.

MM-metal S

PolymerMetals of the S-basis are used for removing bubbles in cast parts, for quick repairs and for visual improvements. MM-metal is available with high metal filling particular for the cast materials steel, iron, aluminium, copper and bronze.

Machinability: standard tools

MM-Elastomer

MM-Elastomer is a material with rubber-like characteristics. Using MM-Elastomer elastic connections can be created or components repaired which are e.g. subject to abrasion. The range of MM-Elastomer goes from Shore A hardness 40 to 95.

PolymerMetall® • MultiMetall® • Ceramium® • Molymetall® • Sealium®
XETEX® • the MetalExistenceCompany®
are registered trademarks of MultiMetall

TEC-# 016

Sample applications

Used products

PolymerMetals

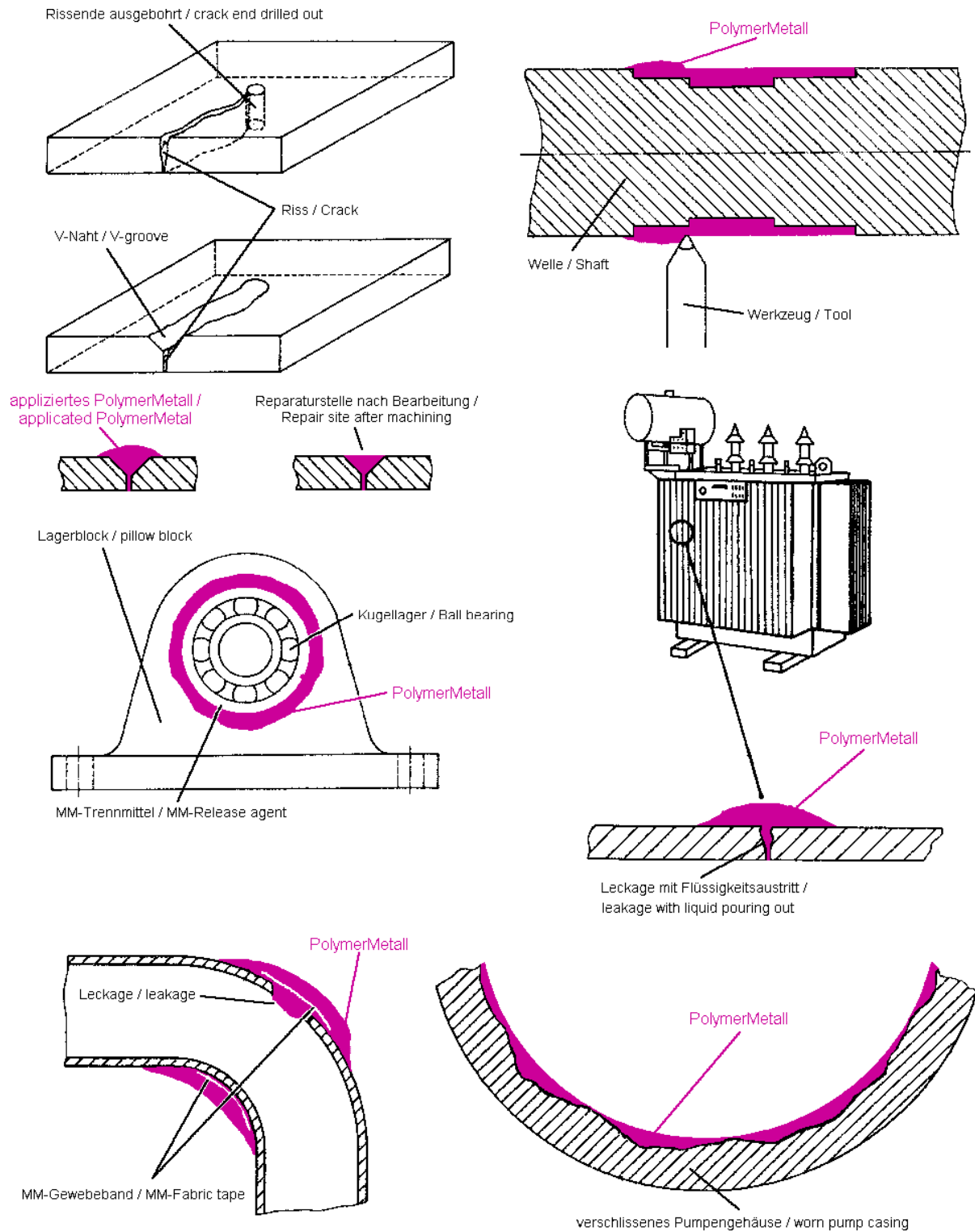

TEC-# 022

Scanning electron microscope records

Used products

PolymerMetalle

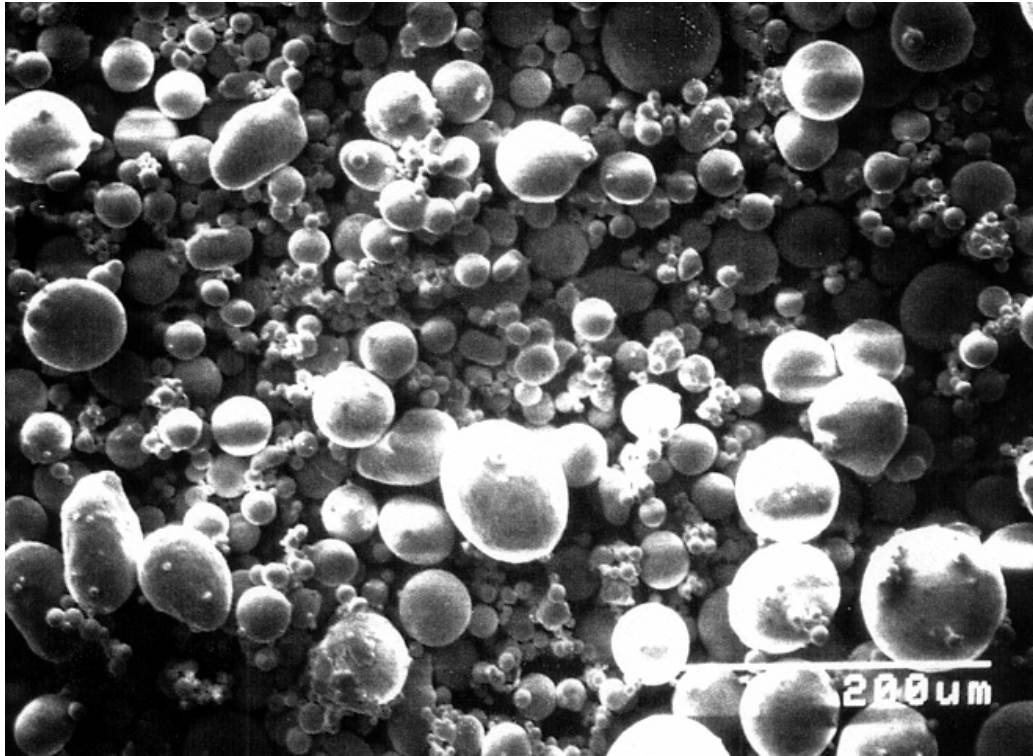

Scanning electron microscope record of a powder particle from an alloy material in the PolymerMetal

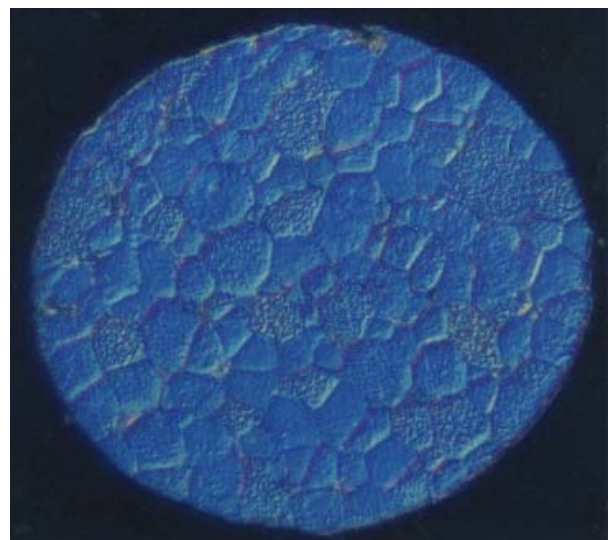
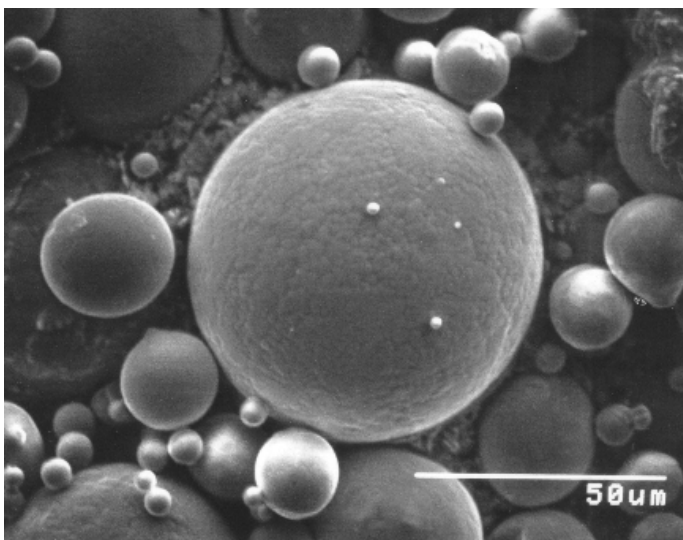

On the left side there is a further record of a powder particle. On the right side can be seen a light-optical polish of cross-section record of a melt atomized and rapidly frozen powder particle.

MultiMetal

the MetalExistenceCompany®

TEC-# 001

Wear behaviour of polymer materials

Used products

Ceramium®, VP 10-017, MM-Elastomer

Description

Mechanical and chemical stress acting on surfaces lead to wear and corrosion. If a high wear resistance is required, usually a very high hardness is needed, too. The hardness – Vickers, Brinell or Rockwell hardness – of polymer materials, like PolymerMetals or polymer ceramics, is meaningless for nearly all wear mechanisms of wear stressed machine parts. Mixtures of ceramic, metallic and polymer materials as well as elastomers show, that wear resistance and hardness do not correspond. Nowadays, erosive-abrasive wear stress is simulated with the help of a slurry pot or an abrasive wheel. The test in the slurry pot is very meaningful when the metals are exposed to sandy streamings. The water-sand mixing ratio determines the degree of wear. The adhesion between the sand grains is rising when the water content is very low. As a result wear is increasing as well. However, the influencing factors in praxis should not be underestimated. Tests carried out in model experiments help to determine the material's quality and to choose the right material. A guarantee for the durability cannot be given by these tests. Ceramium® is a reliable material to protect metals against abrasion and surface destruction provided that the size of the particles is not more than 500 µm. In the following test a medium grain size of a very strong hardness was chosen: SiC ca 60 µm. Water and SiC were mixed in ratio 1 : 2 by volume. It is quite obvious that Ceramium® was exposed to a very high stress.

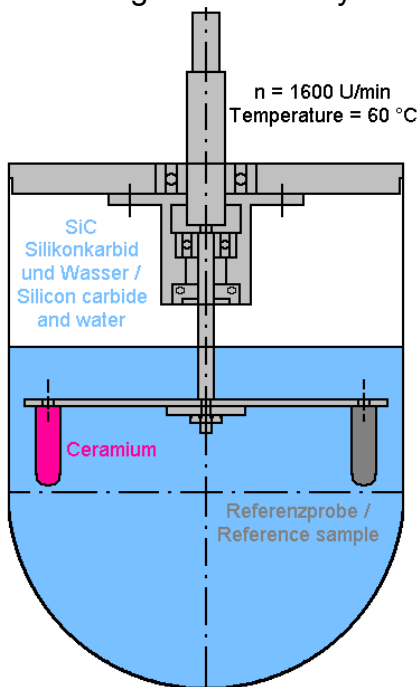

The used materials showed the following results:

Material	Hardness (Vickers)	Wear (after 30 days)
Ceramium®	HV 28	2,93 ccm
Tool steel	HV 840	3,60 ccm
Steel St-52	HV 120	7,20 ccm

In case that the particle size is higher than 500 µm the wear of Ceramium® increases progressively. MM-Elastomer and VP 10-017 show a better wear resistance, because they are plastically deformable. On the other hand, it has to be considered that the bonding on water-stressed metal surfaces of all elastomer materials is diminishing with advancing time.

MultiMetall
the MetalExistenceCompany®

TEC-# 015

Compression strain test

Used products

MM-Elastomer

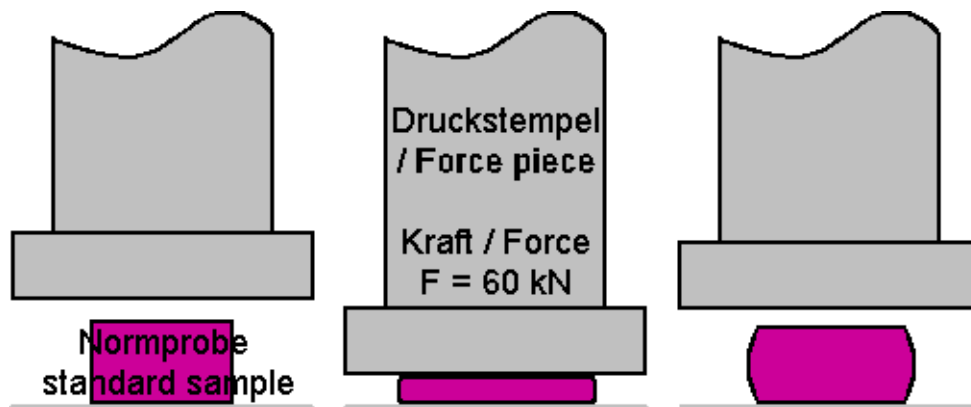

Description

As you can learn from this test, MM-Elastomer disposes high impact strength, hardness and low distortion rest despite of this high use. Furthermore no cracks or excavations could be found after the test. MM-Elastomer is especially suitable for the production of shock and vibration absorbers, cyclone coatings and for the repair of pumps, containers, seals and conveyor belts.

MultiMetal
the MetalExistenceCompany®

Technical Report PolymerMetal®

TEC-# 012

Pressure tightness test of MM-metal UW

Used products

MM-metal UW

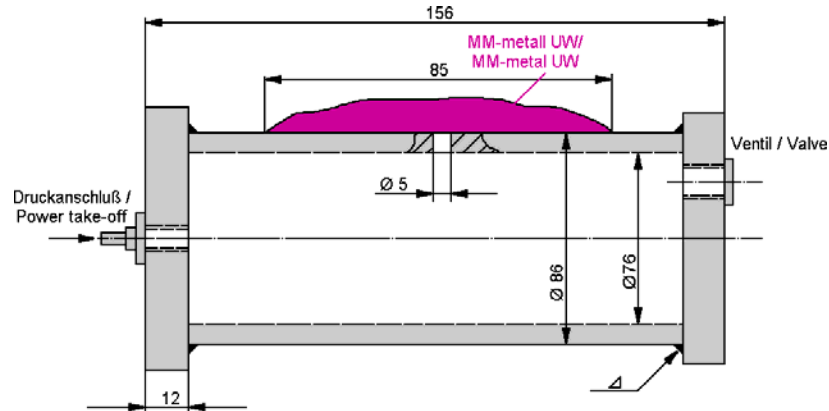

Testing method:

The pressure tightness has been tested at repaired leakages at MAN-testing bodies with MM-metal UW. This test has been carried out according to the test reports of Lloyd's Register of Shipping.

Results:

The following data are from a repair under water with MM-metal UW and Hardener UW9:

<u>Pressure</u>	<u>Data</u>
50 bar	pressure tight
100 bar	pressure tight
120 bar	after 10 min small leakage

The following data were achieved at a repair on a wet metal surface with a first layer of MM-metal UW with Hardener UW3 and a final coating with MM-metal UW and Hardener UW9:

<u>Pressure</u>	<u>Data</u>
100 bar	pressure tight
150 bar	pressure tight
200 bar	after 15 min small leakage

Conclusion:

MM-metal UW can be used in many cases, where an application under water or on wet surfaces is required. The total curing time at 20 °C is between 10 - 60 minutes and a processing is possible up to an ambient temperature of 0 °C. Because of the a.m. technical data MM-metal UW can be used e.g. to seal leakages at water pipings, which need to resist strong pressure.

MultiMetall

the MetalExistenceCompany®

The product information and instructions provided in this leaflet were prepared to the best of our knowledge and serve information purposes only. We recommend that appropriate tests are carried out prior to application in order to ensure that the products and methods fulfil the purpose desired by the user. In this procedure, the given data may serve as a basis. Application and processing of the products lie outside our possible control and are therefore the sole responsibility of the user.



Technical Report PolymerMetal®

TEC-# 007

The corrosion-chemical behaviour of PolymerMetals in combination with casting material (contact corrosion)

Used products

MM-metal SS-steelceramic / MM-metal SQ / MM-metal SS-steel 382 / MM-metal SS-steel / MM-metal oL-steelceramic / MM-metal UW / Ceramium® / MM-metal S-steel

Introduction

PolymerMetals are used for repairs of metallic constructions which were damaged by physical loads like tear, impact, erosion, abrasion, corrosion and cavitation or by chemical load.

Questions of customers concerning the contact corrosion of our PolymerMetals lead us to do tests.

The following report shows how the test has been carried out and what results have been obtained. Tests have been made with seven different PolymerMetals in artificial sea water (laboratory test) as well as in aggressive marshy soil. The PolymerMetals used were potentially equivalent or potentially superior to the base material (cast iron).

Place of repair

Moorland in the North of Germany and laboratory

Preparation of test samples

56 plates measuring 150 x 95 x 25 mm and 95 x 47 mm have been cut off cast iron. The surface of 23 plates has been treated mechanically. 2-3 bore holes of different diameters were installed in order to create different proportions between cast iron and PolymerMetals.

General information

An ordinary salt spray test proved insufficient. As the tested PolymerMetals are non-electrical conductive products it was decided not to measure the current density potential curves. The contact resistance in the Meg-Ohm-sphere was too high.

Test in moorland

Marshy soil is to be said very aggressive (DVGW rating no. -15 up to -19)

Reasons are:

- very low soil resistance (appr. 950-1200 Ohm x cm)
- very high salt content (chloride 800 - 1250 mg/kg / sulphate 4300 - 19000 mg/kg)
- very high moisture contents (appr. 55 - 85%)
- anaerobic conditions, proved by hydrogen-sulphide

The cast iron plates and PolymerMetals, machined and non-machined, were stored in a considerable depth of marshy soil for more than one year.

Test in artificial see water (laboratory test)

The cast iron plates and PolymerMetals - machined and non-machined - were stored in a laboratory in considerable depth of artificial sea water (DIN 50 900) for more than one year.

Samples

The following photographs show the different PolymerMetals applied to cast iron which have been partly machined after full curing. After they have been stored for 12 months in aggressive moorland or artificial sea water the samples have been examined. The following four photographs concern machined samples which have been exposed to artificial sea water:

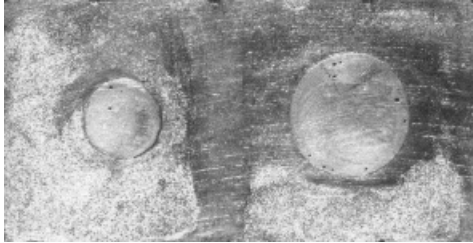

Sample MM-metal SS-steelceramic

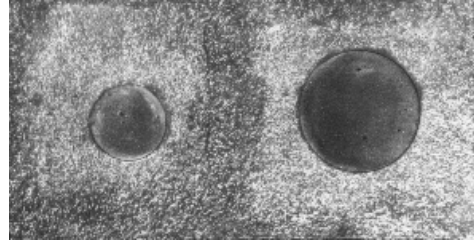

Sample MM-metal SS-steel



Sample MM-metal oL-steelceramic

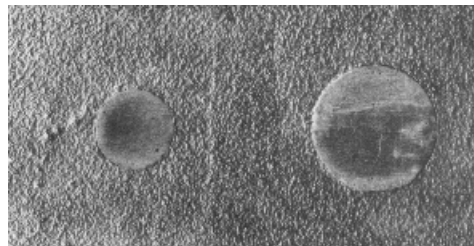

Sample MM-metal UW

Result

The results of both tests were nearly the same. Due to the strong reaction caused by the aggressive soil or by the sea water the cast iron plates were coated with ferric hydroxide. While the surface of the cast iron plates were differently affected, the PolymerMetals still remained unchanged after storage of more than 12 months. They were only covered with rust deposit. Even peak-to-valley heights from previous treatments could clearly be recognised. There was no contact corrosion, not even at the transitional point of the PolymerMetal and the cast iron. It was proved that PolymerMetals are not electrically conductive and cannot constitute any local element with cast iron.

Tested PolymerMetals

MM-metal SS-steelceramic
MM-metal SS-steel 382
MM-metal SS-steel
MM-metal SQ
MM-metal oL-steelceramic
MM-metal UW
Ceranium®
MM-metal S-steel

MultiMetal
the MetalExistenceCompany®



Technical Report PolymerMetal®

TEC-# 006

Microscope photographs, direct-MM-bonding, bonding on contaminated surfaces, pressure tight tests

Used products

MM-metal oL-steelceramic

Description

MM-metal oL-steelceramic is a PolymerMetal tested and certified for the repair of oily, greasy or fuel contaminated metals and alloys in case of stress due to cracks, corrosion, abrasion, impact or chemicals. The degree of soiling does not in any way affect the bonding with the structure of the soiled metal surface. High technical data and also the chemical resistance and bonding with the structure on a dirty metallic surface are remarkable features of MM-metal oL-steelceramic.

This technology is approved by Lloyd's Register of Shipping.

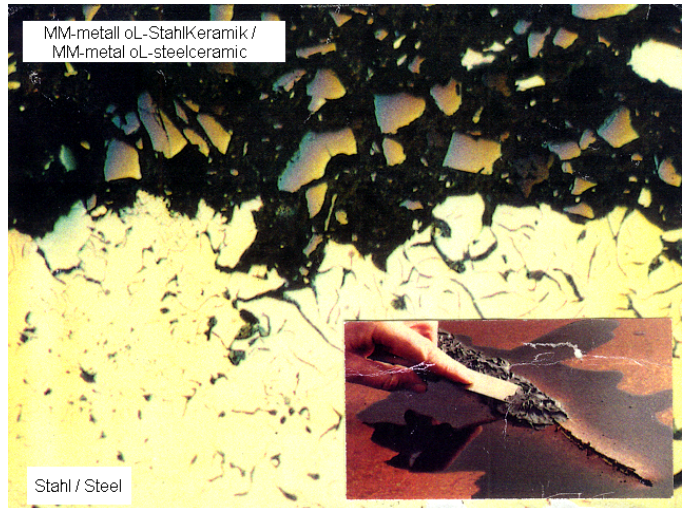

Microscope photographs / direct-MM-bonding

The following pictures show microscopic photographs of the fully cured PolymerMetal MM-metal oL-steelceramic magnified by a factor of 100 and 500. Here the bonding between MM-metal oL-steelceramic and metallic surfaces (steel or casting), which have been contaminated by various applied oils before, has been analyzed.



on industry gear oil / steel
(Magnification 100)



on petroleum / casting
(Magnification 100)



on diesel / steel
(Magnification 100)

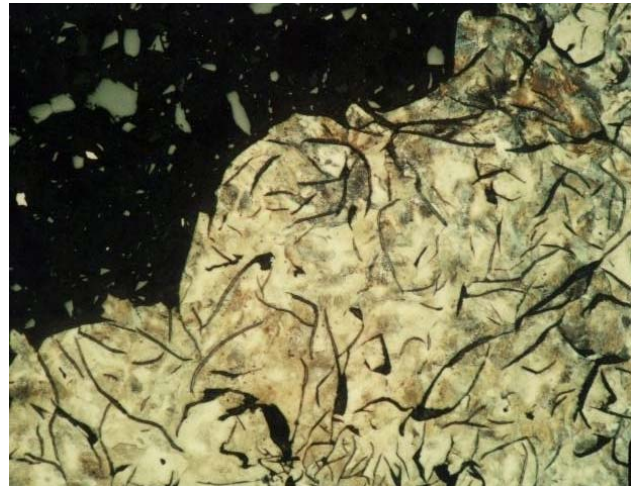

on compression oil KSL 68 / casting
(Magnification 100)

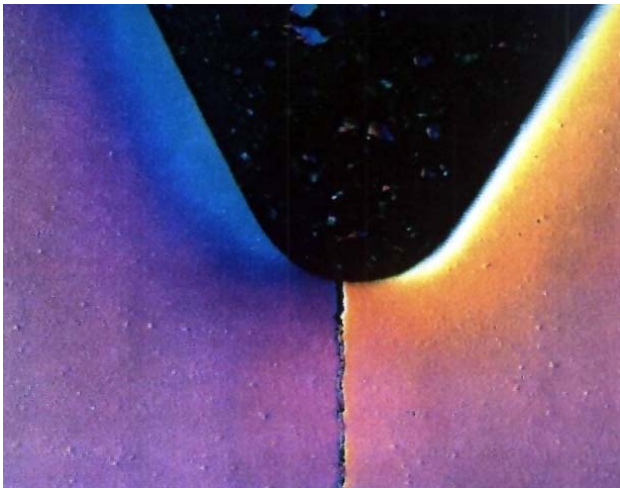

on hydraulic oil T 29-50 / steel
(Magnification 100)

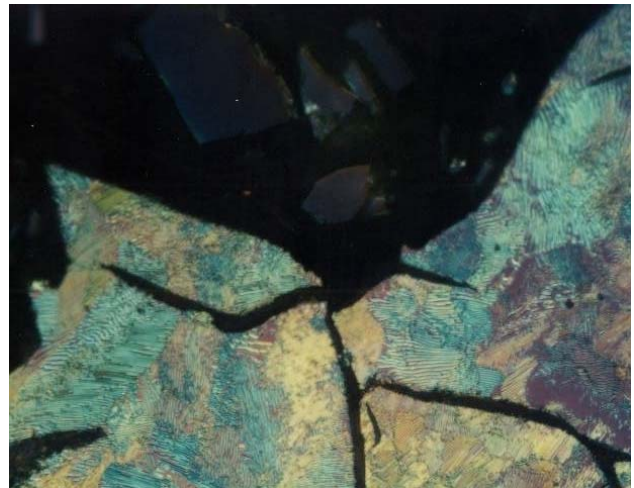

on gear oil / machine oil 55
(Magnification 500)

MM-metal oL-steelceramic penetrates and absorbs oil, grease and fuel. The direct-MM-bonding technology secures the direct and high solid bonding on contaminated surfaces.

Bonding on oily surfaces

Tests have been carried out to evaluate the quality of the bonding on different surfaces. At the reference test MM-metal oL-steelceramic and Hardener yellow have been applied to a cleaned (that means oil free) and roughened metal surface. The reference value of 100% stands for the quality of the various determined technical data during bending, shearing & hydraulic tests after total curing time. Other values have been determined by applying MM-metal oL-steelceramic on different contaminated metal surfaces. The test results demonstrate that sometimes better technical values were reached after application on oily metal surfaces than on clean metal surfaces.

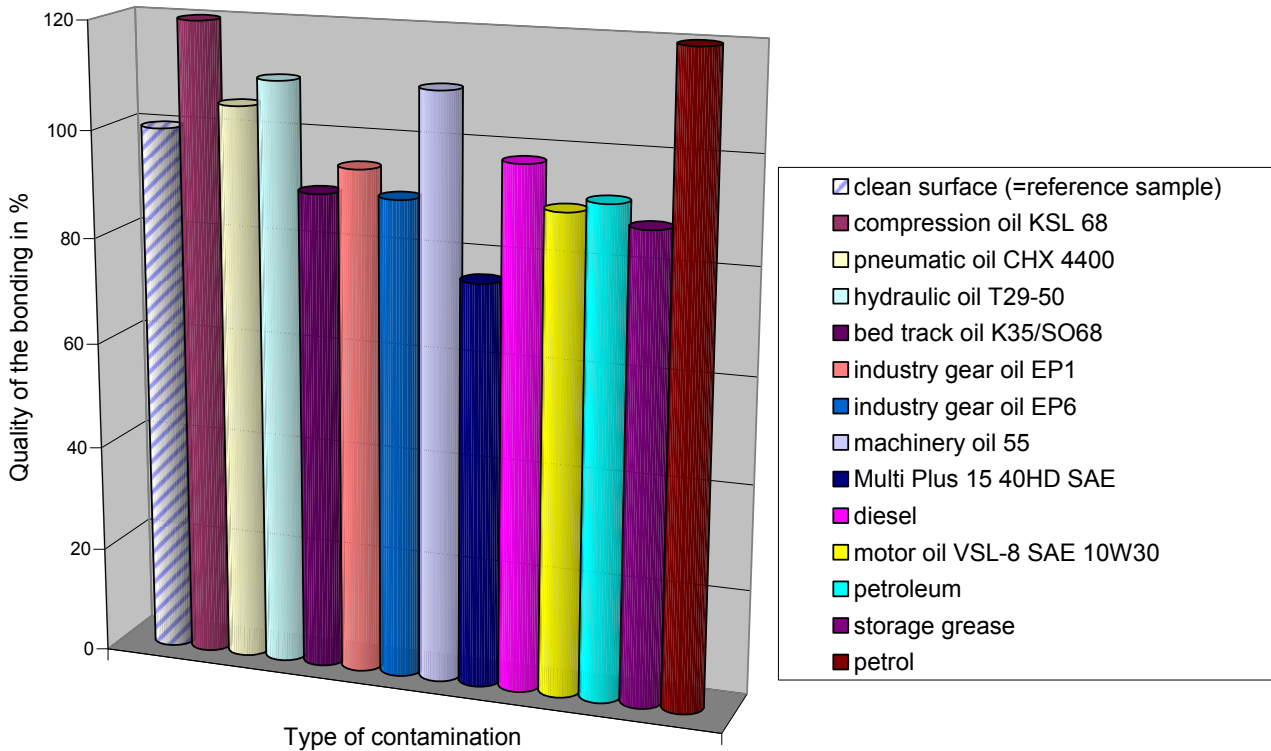

Testing of pressure tightness

To be able to evaluate the quality of the application of MM-metal oL-steelceramic on oily surfaces, tests have been carried out at company M.A.N. under supervision of the classification society Lloyds Register of Shipping. Here special test pipes made off steel have been created according to the following drawing. Around a leakage of a size of diameter 5 mm the metallic shiny surface (Rz 65 µm) of the test cylinder was contaminated with oil. Then the cold-curing MM-metal oL-steelceramic with Hardener yellow was applied around the leakage with a layer thickness of up to max. 8 mm. After full curing of the PolymerMetal the test cylinder has been filled with a liquid and pressure was built up. Then the system was checked against pressure tightness.

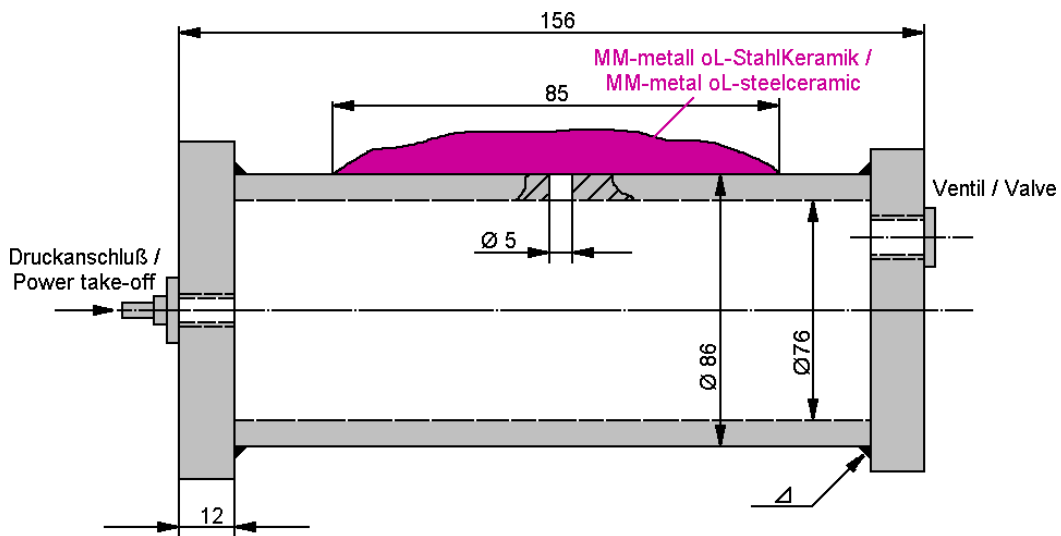

Pressure	Temperature of test cylinder	Auxiliaries	Result
100 bar	20 °C	-	pressure tight
150 bar	20 °C	-	pressure tight
200 bar	20 °C	-	after 8 hours small leakage

In the course of the time the research and development division of MultiMetall was successful to continue optimising the material MM-metal oL-steelceramic and new tests with same conditions have been carried out at MultiMetall. The following results were achieved:

Pressure	Temperature of test cylinder	Auxiliaries	Result
200 bar	20 °C	-	pressure tight
300 bar	20 °C	-	pressure tight
350 bar	20 °C	-	after 2 hours small leakage
150 bar	75 °C	pipe clip	pressure tight
400 bar	75 °C	pipe clip	pressure tight

The pipe clip was fixed around the test cylinder in the area of the leakage. Reinforcing elements as e.g. fibres or mats consisting of glass or carbon have not been used. These would have increased the physical strength essentially.

The tests have been carried out at M.A.N. (test report No. 1731/82) under supervision of Lloyds Register of Shipping (certificate No. 301954) in 1982, the test at MultiMetall in 1995.

Extract of the certificate: „The test results of MM-metal oL-steelceramic may be classed as ranging from good to exceptionally good. All test results were in support of the maker’s claim that MM-metal oL-steelceramic will bond on oily surfaces with a high degree of reliability.”

Practical example

At Weatherford pressure tests have been carried out with MM-metal oL-steelceramic. The test piece was pressure tight up to a tested pressure load of 4.000 psi (~ 275 bar).

Here are some photographs incl. test records:





Weatherford CDL 9405R1c)
 Program : 1.58
 Date : 900025
 Part No. : 0
 Serial No. : 0
 Assembly : 0
 Acquiring Date 21.01.2006
 Acquiring Time 11:00:03

Admin Data

Company ACOTS
 Order no. KLAUS
 Operator

Pipe Data

Pipe Type 31/2" PIPE
 Manufacturer
 Pipe Diameter
 Weight
 Grade
 Lubricant
 Comment

Pressure Values

Pressure Range 5000 psi
 Max. Pressure 4000 psi
 Min. Pressure 1000 psi
 Ref. Pressure 1500 psi

Sensor Data

Sensor Type
 Sensitivity (mV/V) 2.000

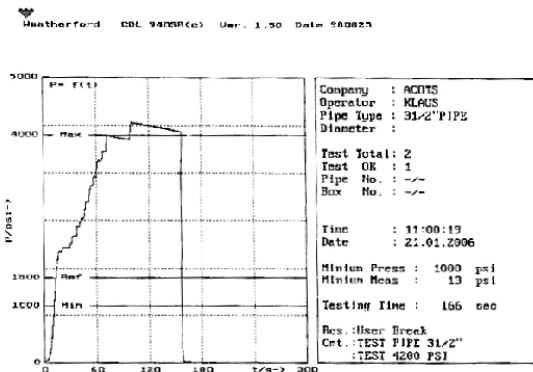

Further information can be provided upon request.

MultiMetal
 the MetalExistenceCompany®

The product information and instructions provided in this leaflet were prepared to the best of our knowledge and serve information purposes only. We recommend that appropriate tests are carried out prior to application in order to ensure that the products and methods fulfil the purpose desired by the user. In this procedure, the given data may serve as a basis. Application and processing of the products lie outside our possible control and are therefore the sole responsibility of the user.



Technical Report PolymerMetal®

TEC-# 023

Comparison compressive strength

Used products

MM-metal SS-steel 382, MM-metal SS-steel

Description

All manufacturers from polymer-metallic repair products are endeavoured to offer highest product quality. To do justice to these requirements, MultiMetall develops and produces polymer-metallic products on a high level.



The strength particularly the compressive strength describes, how much a work piece can be stressed before it breaks.

Important are the cohesion forces which hold together the smallest

parts of a work piece. As soon as the loading exceeds the cohesion forces the work piece breaks.



Based on its high user-orientated and developing potential MultiMetall does have a superior position in the area of polymer-metallic materials for years.



The following table compares the highest compressive strength data of polymer-metallic repair products from other producers with the data of some PolymerMetals produced by MultiMetall. The compressive strength of the MultiMetall-products has been determined by tests executed by IFAM / Germany according to DIN EN ISO 604.



Repair products from other manufacturers	MPa	PSI
Repair product A	156	22620
Repair product B	107	15515
Repair product C	130	18850
Repair product D	120	17400
PolymerMetals from MultiMetall	MPa	PSI
MM-metal SS-steel	180	26100
MM-metal SS-steel 382	211	30595
MM-metal SS-steel 382 (aftercured)	245	35525

Compressive strength

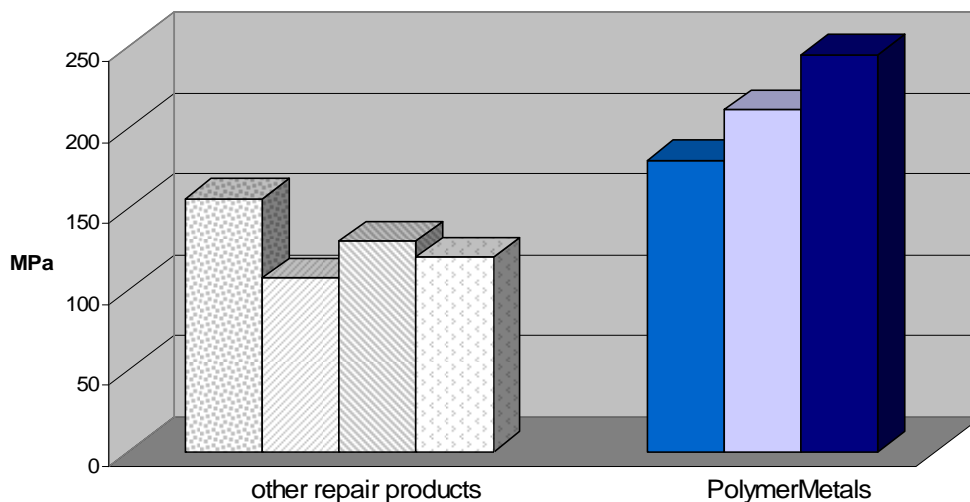

The drawing shows, that MultiMetall's PolymerMetals do without exception deliver higher data in comparison with work piece-similar products from competitors.

MultiMetall
the MetalExistenceCompany®

TEC-# 029

Pressure tight test at low temperatures

Used products

MM-metal SS-steelceramic

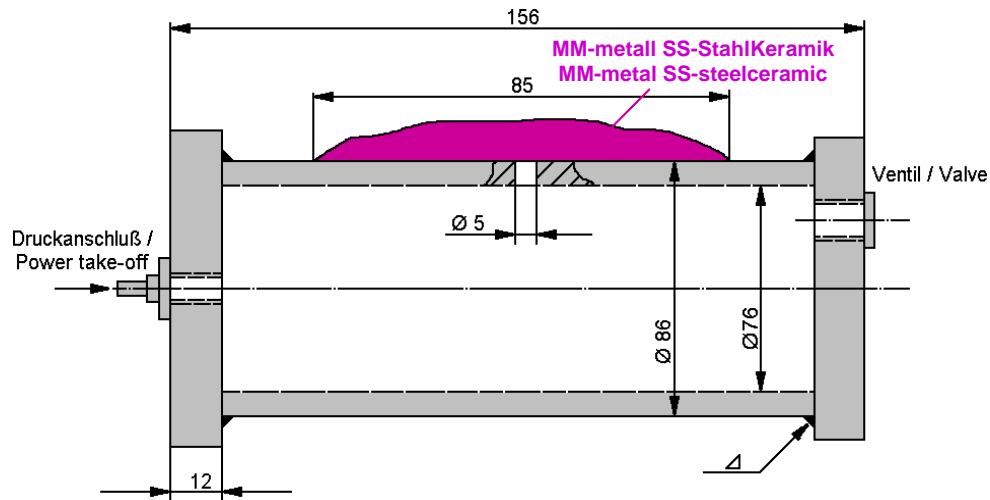

Testing method:

It was tested the pressure tightness of a repaired leakage at a test cylinder according to above drawing. For this MM-metal SS-steelceramic with Hardener yellow has been applied to the dry metal surface. After full curing of 24 h at 21 °C the test cylinder was filled with a liquid (here: oil-water-mixture). Then the test cylinder was cooled down inclusive contained liquid to minus 35 °C and a pressure of 200 bar was built up in the system. This temperature and pressure was kept constant over a testing period of 50 h. This test was carried out concerning special repair demands of a customer (permanent pressure of 200 bar at a very low temperature of minus 35 °C).

Results / conclusion:

Although low temperature and high pressure are effective at the same time, there has not been measured any pressure reduction in the system after expiration of the test period. MM-metal SS-steelceramic in combination with Hardener yellow is a high-quality repair material, which withstands high permanent pressures even at very low temperatures.

MultiMetal
the MetalExistenceCompany®

The product information and instructions provided in this leaflet were prepared to the best of our knowledge and serve information purposes only. We recommend that appropriate tests are carried out prior to application in order to ensure that the products and methods fulfil the purpose desired by the user. In this procedure, the given data may serve as a basis. Application and processing of the products lie outside our possible control and are therefore the sole responsibility of the user.

Technical Report PolymerMetal®

TEC-# 030

High stress due to temperature, chemicals (aggressive lye) and erosion affecting at the same time

Used products
Ceranium®

Experience report of a producer of aluminium oxide

The favourable properties of the producer of the material Ceranium® prompted us to check if the technical data are valid also for the present operating conditions. For a realistic evaluation it is important to record the operating times.

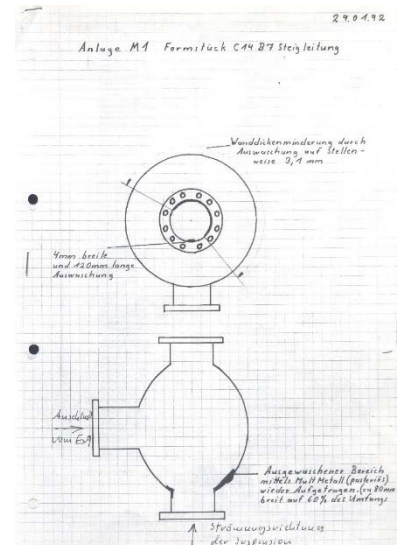
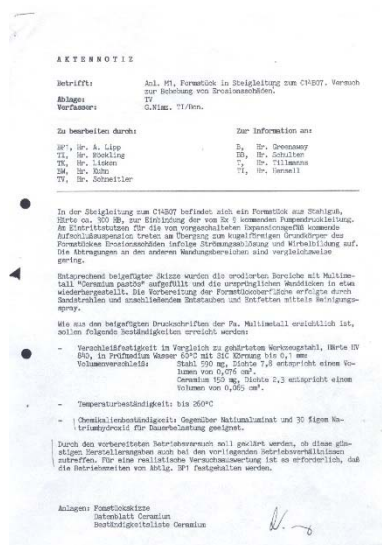
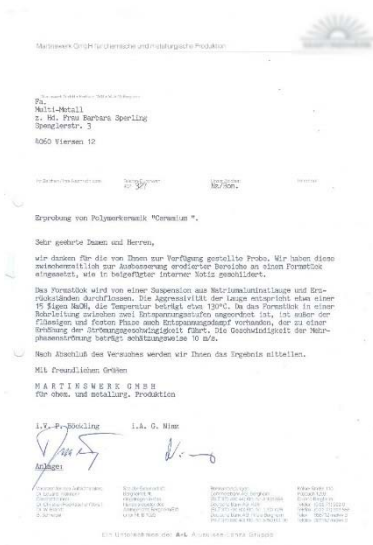

Subject: examination concerning the removal of erosion damages with Ceranium®

Objekt/work piece: structural part of steel casting Brinell hardness 300

Medium: suspension consisting of
 - sodium aluminate lye Na_2O 200 g/l
 - aluminium oxide Al_2O_3 240 g/l
 - ore remains
 (The aggressiveness of the sodium aluminate lye more or less corresponds to sodium hydroxide NaOH of a concentration of 15%)

volume flow ~ 150 m³/h
 velocity 10 m/s

Operating temp.: 135 °C

Operating pressure: ~ 2 bar

Description:

The standpipe to the C14B07 has a structural part made of steel casting of Brinell hardness 300. Damages were caused by erosion due to burbling and formation of whirls. According to the drawing on the right side the eroded areas were refilled with Ceramium® pasty. Therefore the original wall thickness was restored. The surfaces were sand blasted, made dust free and degreased before.

After appr. 4 months a revision was carried out. No visible erosion damages at the surfaces coated with Ceramium® were found. The areas of the steel casting which were not coated with Ceramium showed very severe erosion damages.

Result:

The test showed that Ceramium® fulfils the conditions for the repair of damaged metal surfaces. At the same time the wear resistance will be improved.

Note:

The original text of the customer was summarised.

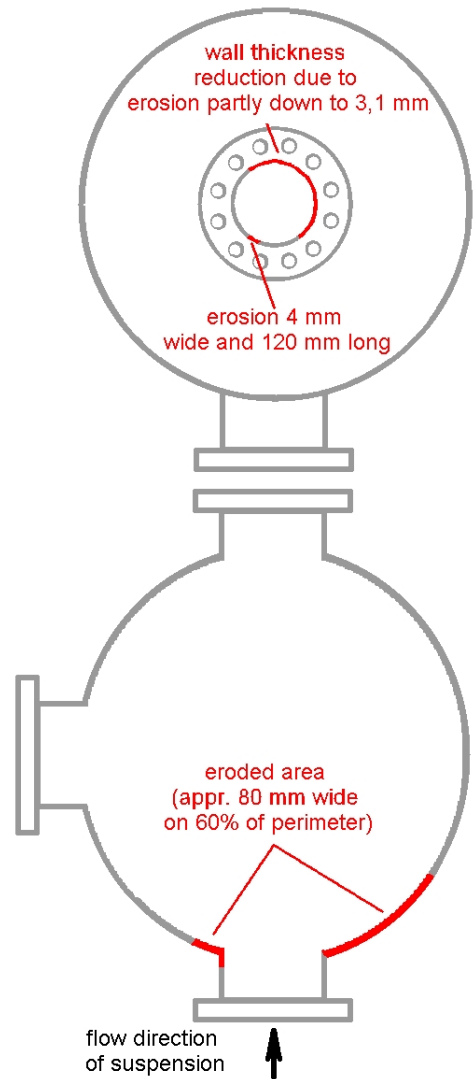

MultiMetall
the MetalExistenceCompany®

The product information and instructions provided in this leaflet were prepared to the best of our knowledge and serve information purposes only. We recommend that appropriate tests are carried out prior to application in order to ensure that the products and methods fulfil the purpose desired by the user. In this procedure, the given data may serve as a basis. Application and processing of the products lie outside our possible control and are therefore the sole responsibility of the user.



Worldwide repairs carried out with PolymerMetal®

REP-# 001



Repair of 14 bearing bushes of the gear box, which is destined to the bucket wheel drive of an excavator for the field of open-cast mining. The worn bearing bushes with a diameter of 280 to 580 mm and a width of 130 to 150 mm were reconstructed with MM-metal SS-steelceramic and Hardener yellow. The standstill time of the excavator was considerable reduced to 72 hours.

MultiMetal
the MetalExistenceCompany®



Worldwide repairs carried out with PolymerMetal[®]

REP-# 125



Repair of two-stroke engine cylinder liners Sulzer RND 76N ship's diesel engine with MM-metal SS-steel and Hardener yellow. The outer diameter is 900 mm and the inner diameter is 760 mm.

MultiMetal
the MetalExistenceCompany[®]



Worldwide repairs carried out with PolymerMetal®

REP-# 115



Repair of a leaking simplex compact packing. The repair was difficult due to oil pouring out of the repair site. Therefore it was decided to use the direct-MM-bonding method by applying the PolymerMetal directly on the greasy surface. Here MM-metal oL-steelceramic with Hardener red was chosen.

MultiMetall
the MetalExistenceCompany®



Worldwide repairs carried out with PolymerMetall®

REP-# 131



Due to ageing and sea water corrosion, the hard chrome coating in the top section of some hydraulic rams of several vessel deck hatch covers was peeled off. To avoid re-chroming, the hydraulic rams were repaired with Molymetall. First the corroded areas were machined down. Then Molymetall was applied and after curing machined down to size. The 270 kg heavy hydraulic cylinders with a diameter of 125 mm work with a pressure of 280 kg/cm² and a stroke of 635 mm. Tests, carried out 5 years after the repair, show that the hydraulic rams are still in good condition and fully functional.

MultiMetall
the MetalExistenceCompany®



Worldwide repairs carried out with PolymerMetal[®]

REP-#140



In a steel plant the repair of a broken spool reducer with a weight of 40 t would have taken up 10 days by using the conventional way of welding. By using the repair technology of MultiMetall combined with the PolymerMetal MM-metal SS-steel and MM-Release agent a repair time of just 27 hours was necessary. At the spool reducer a stress of 120 MPa occurs.

MultiMetall
the MetalExistenceCompany[®]



Worldwide repairs carried out with PolymerMetal®

REP-#145



A reeling machine was worn out due to abrasion. After roughening the surface to be treated, it was coated with the PolymerMetal MM-metal SS-steel and therefore put into working order again.

MultiMetal
the MetalExistenceCompany®



Worldwide repairs carried out with PolymerMetal®

REP-#155



Repair of a vertical crack in a welding in length of ~ 80 mm by using the repair technology “direct-MM-bonding” with the help of MM-metal oL-steelceramic and the hardeners red and yellow.

MultiMetal
the MetalExistenceCompany®

Produktübersicht / Product Overview

Prod-#	Produkt (Deutsch / German)	Product (Englisch / English)	Einheit/Unit	Notizen/Notes
	MM-metall SS-StahlKeramik	MM-metal SS-steelceramic		
200	MM-metall SS-StahlKeramik, pst.	MM-metal SS-steelceramic, pst.	1000 g	
249	Härter gelb, pst.	Hardener yellow, pst.	50 g	
248	Härter rot, pst.	Hardener red, pst.	100 g	
	MM-metall SQ	MM-metal SQ		
300	MM-metall SQ, pul.	MM-metal SQ, pow.	1000 g	
301	Härter SQ2, fl.	Hardener SQ2, liq.	220 g	
302	Härter SQ8, fl.	Hardener SQ8, liq.	220 g	
	MM-metall SS-Stahl 382	MM-metal SS-steel 382		
217	MM-metall SS-Stahl 382, pst.	MM-metal SS-steel 382, pst.	1000 g	
249	Härter gelb, pst.	Hardener yellow, pst.	50 g	
218	MM-metall SS-Stahl 382, fl.	MM-metal SS-steel 382, liq.	1000 g	
250	Härter gelb, fl.	Hardener yellow, liq.	50 g	
	MM-metall SS, pastöse Konsistenz	MM-metal SS, pasty consistency		
201	MM-metall SS-Stahl, pst.	MM-metal SS-steel, pst.	1000 g	
205	MM-metall SS-Aluminium, pst.	MM-metal SS-aluminium, pst.	600 g	
209	MM-metall SS-Kupfer, pst.	MM-metal SS-copper, pst.	1000 g	
211	MM-metall SS-Bronze, pst.	MM-metal SS-bronze, pst.	1000 g	
249	Härter gelb, pst.	Hardener yellow, pst.	50 g	
	MM-metall SS, flüssige Konsistenz	MM-metal SS, liquid consistency		
202	MM-metall SS-Stahl, fl.	MM-metal SS-steel, liq.	1000 g	
206	MM-metall SS-Aluminium, fl.	MM-metal SS-aluminium, liq.	600 g	
210	MM-metall SS-Kupfer, fl.	MM-metal SS-copper, liq.	1000 g	
212	MM-metall SS-Bronze, fl.	MM-metal SS-bronze, liq.	1000 g	
250	Härter gelb, fl.	Hardener yellow, liq.	50 g	
	MM-metall oL-StahlKeramik	MM-metal oL-steelceramic		
2460	MM-metall oL-StahlKeramik, pst.	MM-metal oL-steelceramic, pst.	1000 g	
249	Härter gelb, pst.	Hardener yellow, pst.	50 g	
248	Härter rot, pst.	Hardener red, pst.	100 g	
246	MM-metall oL-StahlKeramik, pst.	MM-metal oL-steelceramic, pst.	500 g	
253	Härter gelb, pst.	Hardener yellow, pst.	25 g	
248	Härter rot, pst.	Hardener red, pst.	100 g	
	MM-metall UW	MM-metal UW		
1160	MM-metall UW, pul.	MM-metal UW, pow.	1000 g	
1170	Härter UW3, fl.	Hardener UW3, liq.	250 g	
1180	Härter UW9, fl.	Hardener UW9, liq.	250 g	
116	MM-metall UW, pul.	MM-metal UW, pow.	500 g	
117	Härter UW3, fl.	Hardener UW3, liq.	125 g	
118	Härter UW9, fl.	Hardener UW9, liq.	125 g	
	Ceramium®	Ceramium®		
601	Ceramium, pst.	Ceramium, pst.	695 g	
611	Härter CE, pst.	Hardener CE, pst.	55 g	
602	Ceramium, fl.	Ceramium, liq.	695 g	
607	Härter CE, fl.	Hardener CE, liq.	55 g	
	Ceramium® CH	Ceramium® CH		
622	Ceramium CH, pst.	Ceramium CH, pst.	1000 g	
623	Härter CH1, pst.	Hardener CH1, pst.	75 g	
624	Härter CH1, fl.	Hardener CH1, liq.	65 g	
625	Härter CH2, pst.	Hardener CH2, pst.	80 g	
626	Härter CH2, fl.	Hardener CH2, liq.	70 g	
	XETEX® BD	XETEX® BD		
455	XETEX BD, pst.	XETEX BD, pst.	750 g	
456	Härter BD, fl.	Hardener BD, liq.	50 g	

Produktübersicht / Product Overview

Prod-#	Produkt (Deutsch / German)	Product (Englisch / English)	Einheit/Unit	Notizen/Notes
	VP 10-017	VP 10-017		
705	VP 10-017, fl.	VP 10-017, liq.	800 g	
706	Härter VP 10-017 rot, fl.	Hardener VP 10-017 red, liq.	400 g	
707	Härter VP 10-017 grau, fl.	Hardener VP 10-017 grey, liq.	400 g	
	VP 10-500	VP 10-500		
701	VP 10-500, pst.	VP 10-500, pst.	650 g	
711	Härter VP 10-500, pst.	Hardener VP 10-500, pst.	650 g	
702	VP 10-500, str.	VP 10-500, br.	650 g	
712	Härter VP 10-500, str.	Hardener VP 10-500, br.	650 g	
	Molymetall®	Molymetall®		
401	Molymetall, pst.	Molymetall, pst.	800 g	
403	Härter Molymetall, pst.	Hardener Molymetall, pst.	30 g	
404	Härter Molymetall, fl.	Hardener Molymetall, liq.	30 g	
	Sealium®	Sealium®		
551	Sealium, fl.	Sealium, liq.	2000 ml	
	MM-metall S	MM-metal S		
101	MM-metall S-Stahl, pul.	MM-metal S-steel, pow.	1000 g	
102	MM-metall S-Eisen, pul.	MM-metal S-iron, pow.	1000 g	
105	MM-metall S-Aluminium, pul.	MM-metal S-aluminium, pow.	650 g	
108	MM-metall S-Kupfer, pul.	MM-metal S-copper, pow.	1650 g	
109	MM-metall S-Bronze, pul.	MM-metal S-bronze, pow.	1650 g	
147	Härter S8, fl.	Hardener S8, liq.	250 g	
148	Härter S15, fl.	Hardener S15, liq.	250 g	
	MM-Elastomer	MM-Elastomer		
951	MM-Elastomer 95, pst.	MM-Elastomer 95, pst.	370 g	
952	MM-Elastomer 95, fl.	MM-Elastomer 95, liq.	370 g	
953	MM-Elastomer 95, str.	MM-Elastomer 95, br.	370 g	
962	Härter EL95, fl.	Hardener EL95, liq.	110 g	
956	MM-Elastomer 85, fl.	MM-Elastomer 85, liq.	370 g	
964	Härter EL85, fl.	Hardener EL85, liq.	110 g	
958	MM-Elastomer 65, fl.	MM-Elastomer 65, liq.	370 g	
966	Härter EL65, fl.	Hardener EL65, liq.	74 g	
960	MM-Elastomer 40, fl.	MM-Elastomer 40, liq.	370 g	
968	Härter EL40, fl.	Hardener EL40, liq.	89 g	
	MM-Sets	MM-Sets		
802	MM-Basic Set	MM-Basic Set	Stück / pc	
803	MM-Set SS	MM-Set SS	Stück / pc	
804	MM-Set oL	MM-Set oL	Stück / pc	
805	MM-Set UW	MM-Set UW	Stück / pc	
806	MM-Set VP 10-500	MM-Set VP 10-500	Stück / pc	
	Zubehör	Accessories		
10	MM-Lösung Z, fl.	MM-Degreaser Z, liq.	1000 ml	
11	MM-Lösung Z, fl.	MM-Degreaser Z, liq.	250 ml	
14	MM-Trennmittel, fl.	MM-Release agent, liq.	100 ml	
33	Mischplatte (Kunststoff)	Mixing plate (synthetic material)	20 x 12 cm	
16	Mischstab (rostfreier Stahl)	Mixing stick (stainless steel)	Stück / pc	
15	Mischbecher (Kunststoff)	Mixing cup (synthetic material)	Stück / pc	
25	Messlöffel rot	Measuring spoon red	Satz / set	
26	Messlöffel gelb	Measuring spoon yellow	Satz / set	
29	Messlöffel VP 10-500	Measuring spoon VP 10-500	Satz / set	
18	Gewebeband (rostfreier Stahl)	Fabric tape (stainless steel)	100 x 10 cm	
20	Gewebeband (Glasfaser)	Fabric tape (glass fibre)	1000 x 5 cm	
22	Gewebematte (Glasfaser)	Fabric mat (glass fibre)	30 x 40 cm	
23	Applikationsroller	Application roller	Stück / pc	
34	Temperaturindikator (Einweg)	Temperature indicator (one-way)	15 Stück / pc	

Hinweise / Notes:

Konsistenz/consistency: pst./pst.=pastös/pasty; fl./liq.=flüssig/liquid; pul./pow.=pulverig/powdery; str./br.=streichbar/brushable

EXW = Lieferung ab Lager Deutschland excl. Verpackung / delivery ex works stock Germany excl. packing

MultiMetall
P.O. Box 12 02 64
41720 Viersen
Germany



Tel: +49 - (0) 21 62-97 00 9-0
Fax: +49 - (0) 21 62-97 00 9-11
Email: info@polymermetal.com
Web: www.polymermetal.com

Version (20.11.2013)

In order to find out which PolymerMetall® could be used to solve your repair problem we would like to ask you to fill in and send back this form. Additional sketches, drawings, photographs etc. could be helpful. We thank you for your effort!

Description of the device

Machine/Plant/Construction:

Damaged device (Name):

Function:

Material of the device:

Relevant dimensions (e.g. length, width, height, diameter, wall thickness...):
of the device:
of the damaged area:

Damage description (e.g. crack, wear, leakage,... – in detail please):
.....
.....
.....

Reason and cause of damage (Why?... Whereby?... – in detail please):
.....
.....

Constructive weakening (structural/mechanical strength) of the device due to damage
 No | Yes

Notes/Other:

Influences on the repair area at operating conditions







Thermal stress
min °C | max °C | Durable Ø °C

Mechanical stress
 No | Yes MPa | Yes

Pressure load by fluids
 No | Yes bar | Yes.....

Chemical stress
 No | Yes Chemical(s) (if so with concentration data)
..... °C
..... °C
..... °C

Tribological stress

<input type="checkbox"/> No <input type="checkbox"/> Yes		Sliding wear (Adhesion)	<input type="checkbox"/> Yes		Impact particle wear (Abrasion)
<input type="checkbox"/> Yes		Sliding abrasion (Abrasion)	<input type="checkbox"/> Yes		Drop erosion wear (Surface fatigue)
<input type="checkbox"/> Yes		Particle erosion – fluids (Erosion, Abrasion)	<input type="checkbox"/> Yes		Cavitation wear (Surface fatigue)

